

Title		
Size	Number	Revision
A4		
Date:	8/26/2023	Sheet of
File:	J:\3D打印主板\core核心板系列\H5-RPDCM4.Brd	

A

B

C

D

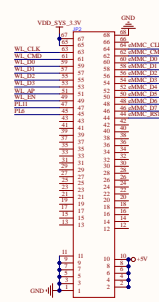
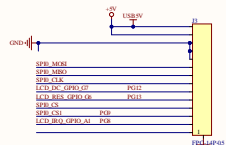
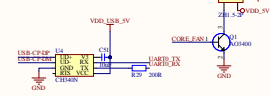
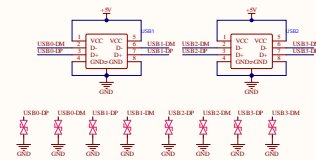
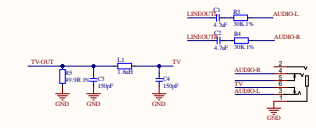

TF-CARD

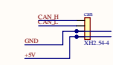
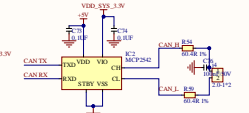
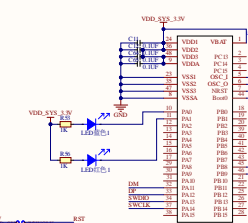
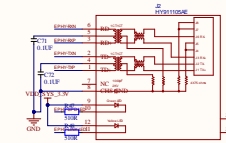
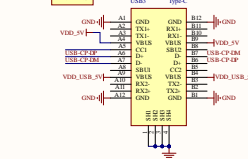
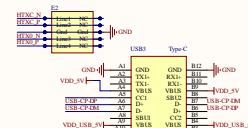
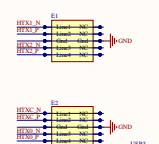
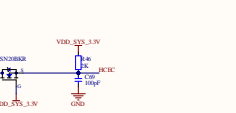
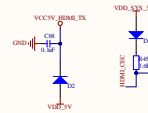
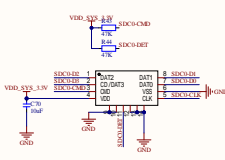

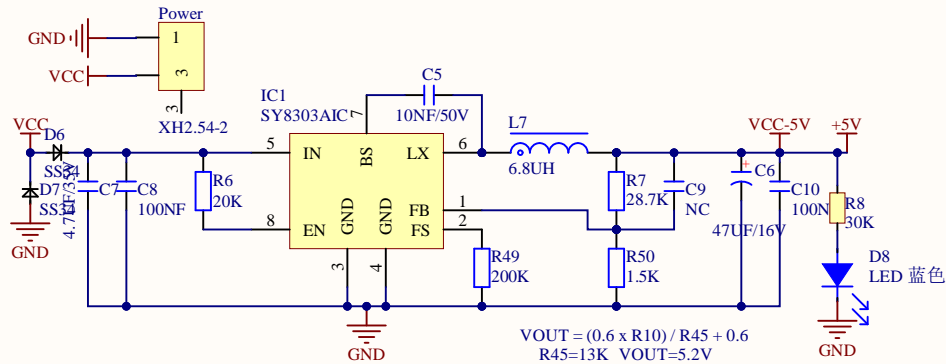

5V TO 3.3V

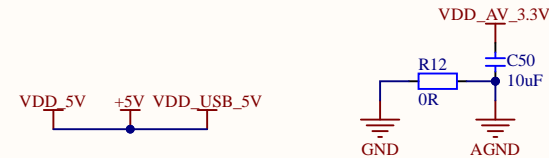
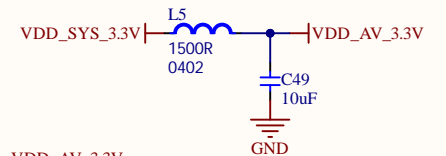
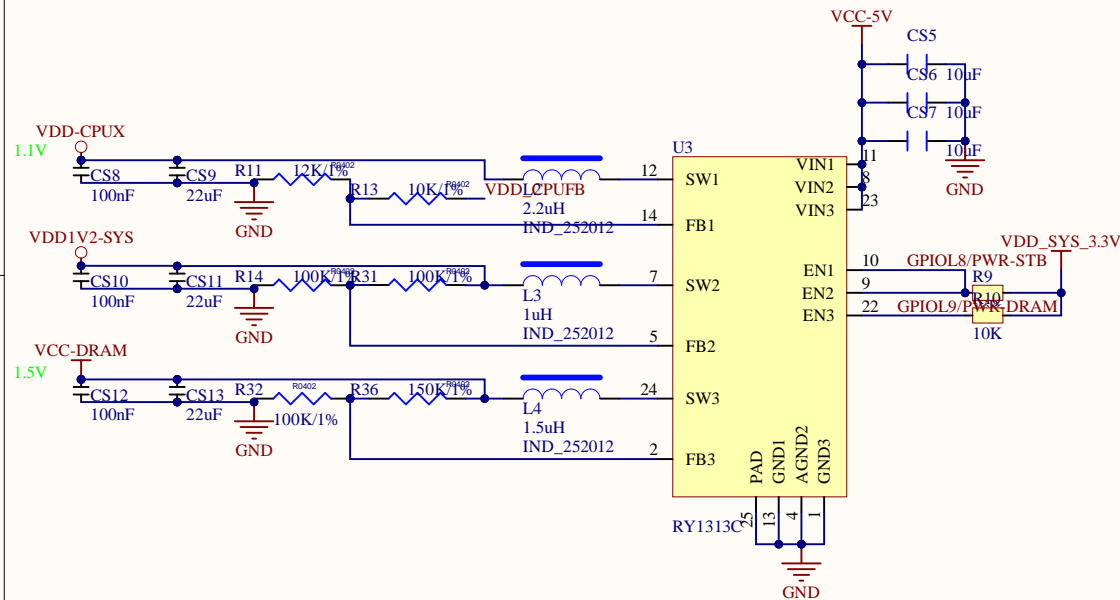
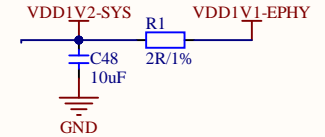
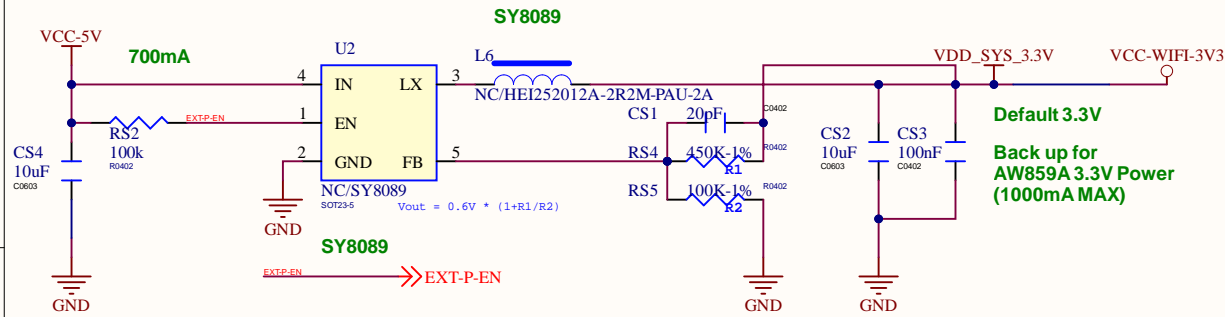

Title		
Size	Number	Revision
A4		
Date:	8/26/2023	Sheet of
File:	J:\3D打印主板\core核心板系列\H5-RPDPowerESchDoc	